

**PS5R Standard Series
Switching Power Supplies**

Key features:

- Wide power range: 7.5W-480W
- Universal input :
7.5W-50W: 85-264V AC/105-370V DC
100W: 85-132V AC/170-264V AC
240-370V DC (selectable)
75W, 120W, 240W: 85-264V AC/110-350V DC
480W: 3 phase: 320- 575V AC
3 phase: 360- 575V AC
- Overcurrent/overvoltage protection
- Power Factor Correction (75W, 120W, 240W models)
EN61000-3-3
EN61000-3-2
- Voltage adjustment +10%
- Spring-up crew terminal, IP20 (finger-safe)
- DIN rail or panel surface mount
- Approvals:
CE marked
UL 508 Listed
c-UL
TÜV approved
LVD EN60950:2000

EMC Directives:
EN50081-2
EN50082-2
EN61000-6-2



Part Numbers

Style	Output Capacity	Input Voltage	Output Voltage	Rated Current	Part Number	Style	Output Capacity	Input Voltage	Output Voltage	Rated Current	Part Number		
	7.5	85 to 264V AC	5V DC	1.5A	PS5R-A05		75	85 to 264V AC	24V DC	3.1A	PS5R-Q24		
			12V DC	0.6A	PS5R-A12					100	24V DC	4.2A	PS5R-E24
			24V DC	0.3A	PS5R-A24								
	15	85 to 264V AC	5V DC	2.5A	PS5R-B05		120	100 to 240V AC	24V DC	5A	PS5R-F24		
			12V DC	1.2A	PS5R-B12					240	24V DC	10A	PS5R-G24
	30	85 to 264V AC	24V DC	0.6A	PS5R-B24		480	320 to 575V AC (3 phase) 360 to 575V AC (2 phase)				24V DC	20A
			12V DC	2.5A	PS5R-C12					50	24V DC	2.1A	PS5R-D24
	50	85 to 264V AC	24V DC	1.3A	PS5R-C24								

* 3-Phase

OT Touchscreens

PLCs

Automation Software

Power Supplies

Sensors

Communication

Barriers

Specifications

Model	PS5R-A05	PS5R-B05*	—	—	—	—	—	—	—			
	PS5R-A12	PS5R-B12	PS5R-C12	—	—	—	—	—	—			
	PS5R-A24	PS5R-B24	PS5R-C24	PS5R-D24	PS5R-Q24	PS5R-E24	PS5R-F24	PS5R-G24	PS5R-TJ24			
Output Capacity	7.5W	15W	30W	50W	75W	100W	120W	240W	480W			
Input	Input Voltage (single-phase, 2-wire)		100 to 240V AC nominal (85 to 264V AC), 50/60Hz (47 to 63Hz) 110 to 340V DC nominal (105 to 370V DC)				100 to 120V AC, 50/60Hz 200 to 240V AC, 50/60Hz (jumper selectable) 240 to 370V DC		100 to 240V AC, 50/60Hz, 110 to 340V DC		3 phase: 320 to 575V AC 2 phase: 360 to 575V AC	
	Input Current (typical)		0.17A at 100V AC	0.3A at 100V AC	0.68A at 100V AC	1.15A at 100V AC	1.1A at 100V AC	2.5A at 100V AC 1.5A at 200V AC	1.8A at 100V AC	4A at 100V AC	3 x 1.1A 3 x 0.8A	
	Internal Fuse Rating		2A	2A	3.15A	3.15A	3.15A	4A	4A	6.3A		
	Inrush Current		50A maximum (at cold start at 200V AC)				70A maximum (at cold start at 230V AC)	50A maximum (at cold start at 200V AC)	70A maximum (at cold start at 230V AC)		21A na	
	Leakage Current (at no load)		0.75mA maximum (60Hz, measured in conformance with UL, CSA, VDE)									<3.5ml
	Typical Efficiency		69% at 5V 75% at 12V 79% at 24V		75% at 12V 75% at 24V	79% at 24V	83% at 24V	85% at 24V	83% at 24V		91%	
	Overvoltage Protection		Outputs turns off at 105% (typical)									
Output	Voltage and Current Ratings		5V, 1.5A 12V, 0.6A 24V, 0.3A	5V, 2.5A 12V, 1.2A 24V, 0.6A	12V, 2.5A 24V, 1.3A	24V, 2.1A	24V, 3.1A	24V, 4.2A	24V, 5A	24V, 10A	24V, 20A	
	Voltage Adjustments		±10% (V.ADJ screw on top)									
	Output Holding Time		20ms minimum (at full rated input and output)									
	Rise Time		200ms maximum (at full rated input and output)							150ms max.	?	
	Line Regulation		0.4% maximum									
	Load Regulation		1.5% maximum									
	Fluctuation due to Ambient Temperature Change		0.05% maximum									
	Ripple Voltage		2% peak to peak maximum (including noise)									
Overload Protection		120% typical (Zener-limiting)			120% typical, auto reset						125% typical, auto reset	
Operation Indicator		LED (green)										
Parallel Operation Allowed		PS5R-A	PS5R-B	PS5R-C	PS5R-D	PS5R-Q	PS5R-E	PS5R-F	PS5R-G			
Dielectric Strength		No									Yes	Yes
Insulation Resistance		Between input and output terminals: 3,000V AC, 1 minute Between input terminals and housing: 2,000V AC, 1 minute Between output terminal and housing: 500V AC, 1 minute										
Operating Temperature		-10° to +60°C (14° to 140°F) (see derating curves)										
Storage Temperature		-30° to +85°C (-22° to 185°F)										
Operating Humidity		20 to 90% relative humidity (no condensation)										
Vibration Resistance		45m/s ² , 10 to 55Hz, 2 hours on each of 3 axes				10 to 50Hz, 0.75mm p-p, 2 hrs on each of 3 axes					<15Hz amplitude +/- 2.5mm in accordance with IEC 60068-2-6 15 to 150Hz, 2.3g, 90 min.	
Shock Resistance		300m/s ² (30G), 3 shocks in each of 6 directions									30g in all directions in accordance with IEC 60068-2-27	
Approvals		Conforms to EMC Directives EN50081-2 & EN50082-2. LVD Directive EN60529 — Certified to EN60950. UL508 listed. c-UL, TUV approved. CE marked. EN61000-3-2										
Weight		150g	170g	360g	390g	800g	600g	1200g	2000g	2000g		
Termination		Spring-up, fingersafe terminals with captive M3.5 screws										
IP protection		IP20 (finger safe)										
Dimensions H x W x D (mm)		75 x 45 x 70	75 x 45 x95	75 x 90 x 95	75 x 90 x 95	120 x 85 x 140	75 x 145 x 95	120 x 115 x140	120 x 200x 140	130 x 115 x 152.5		
Dimensions H x W x D (inches)		2.95 x 1.77 x 2.76	2.95 x 1.77 x 3.74	2.95 x 3.54 x 3.74	2.95 x 3.54 x 3.74	4.72 x 3.35 x 5.52	2.95 x 5.71 x 3.74	4.72 x 4.53 x 5.52	4.72 x 7.87 x 5.51	5.12 x 4.53 x 6.00		

1. For dimensions, see page 165.

3. *12.5W for 5VDC model.

2. For usage instructions, see page 164.



Temperature Derating Curves

PS5R-A/B

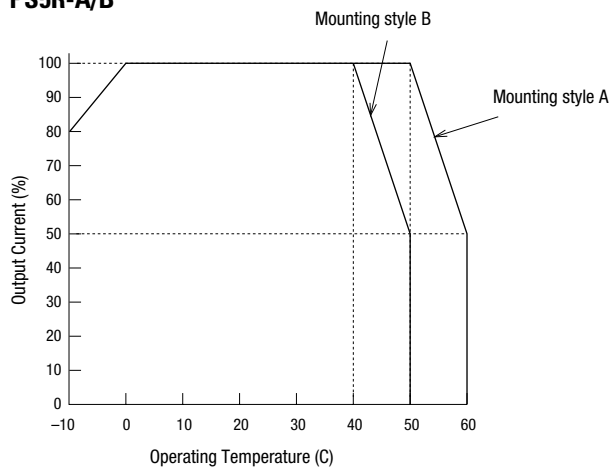

PS5R-C/D

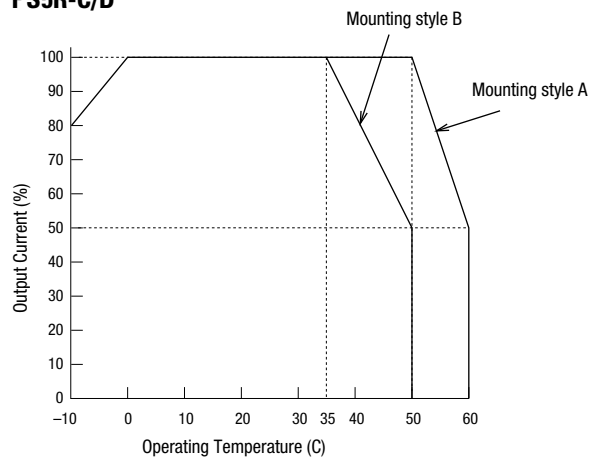

PS5R-E

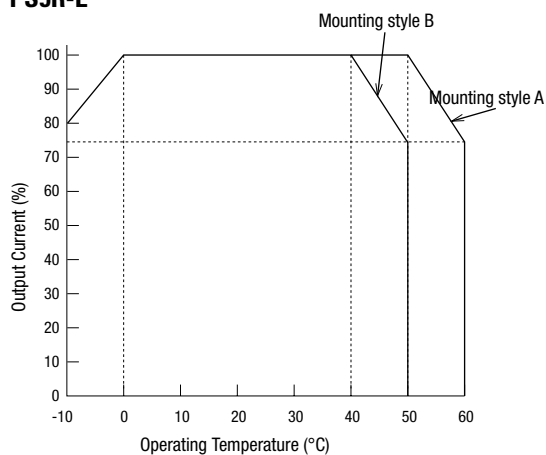

PS5R-Q

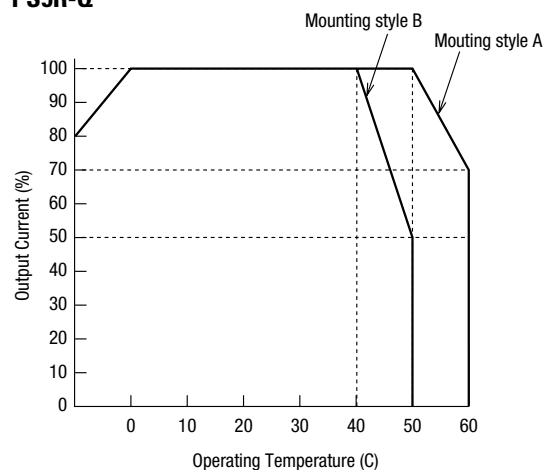

PS5R-F/G

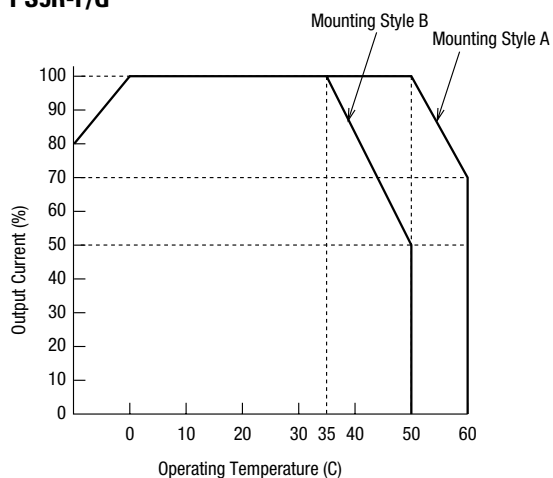

PS5R-TJ

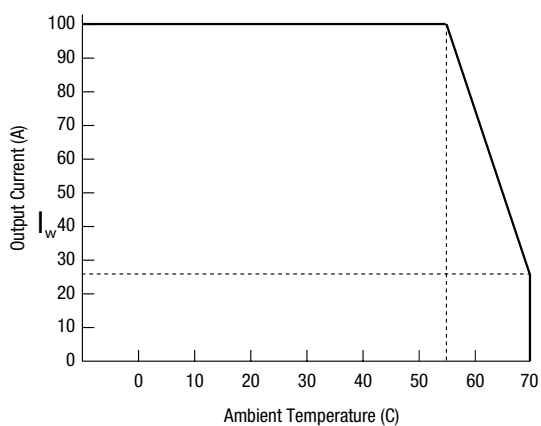

A Mounting (standard)

B Mounting (Facing Upward)

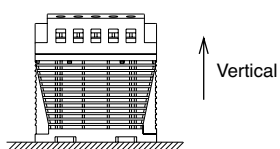
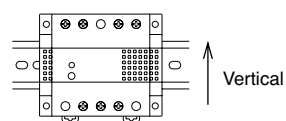

Accessories

Part Numbers: PS5R Accessories

Appearance	Description	Part Number
	DIN rail (1000mm)	BNDN1000
	DIN rail end clip	BNL5

Installation Instructions

Time-Saving Spring-up Terminals

The innovative terminals on the PS5R series use a spring-loaded screw. This makes installation as easy as pushing down and turning with a screwdriver. Installation time is cut in half since the screws do not need to be backed out to install wiring. The screws are held captive once installed and are 100% finger-safe. Screw terminals accept bare wire or ring or fork connectors.

1. Insert the wire connector into the slot on the side of the power supply.



2. Using a flat head or Phillips screwdriver, push down and turn the screw.

The wire is now connected, and the screw terminal is fingersafe!

Front Panel (terminals)

Markings	Name	Description
V. ADJ	Voltage adjustment	Adjusts within $\pm 10\%$; turn clockwise to increase output voltage
DC ON	Operation indicator	Green LED is lit when output voltage is on
+V, -V	DC output terminals	+V: Positive output Terminal -V: Negative output terminal
	Frame ground	Ground this terminal to reduce high-frequency currents caused by switching
L, N	Input terminals	Accept a wide range of voltages and frequencies (no polarity at DC input)
NC	No connection	Do not insert wires here, as this may damage the power supply

Overcurrent Protection Characteristics

PS5R-A/B

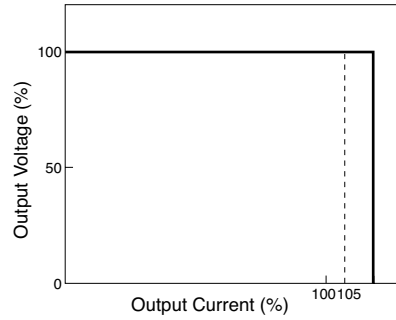

PS5R-C/D/E

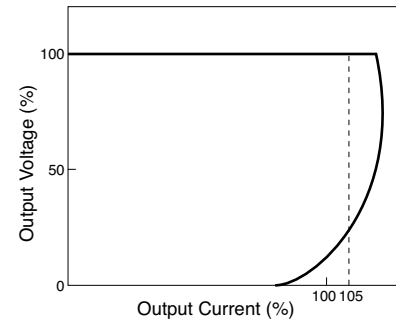

Parallel Operation

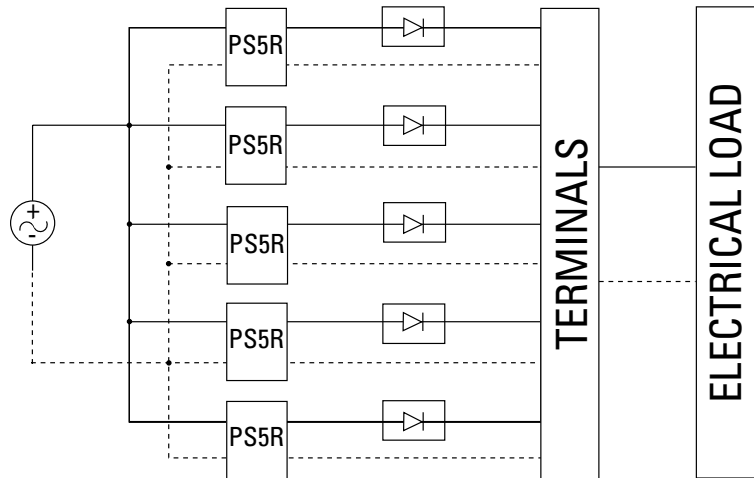

1. Parallel operation only recommended for PS5R-Q24, PS5R-F24 and PS5R-G24.
2. Factory recommended diode ST Microelectronics BYV54V-50, BYV54V-100, BYV54V-200, BYV541V-200 or with equivalent electrical specifications.
3. Using the voltage adjustment make sure out-voltage is the same for all power supplies.

Dimensions

PS5R-A (7.5W)

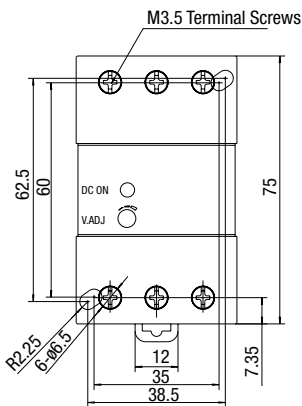

PS5R-B (15W)

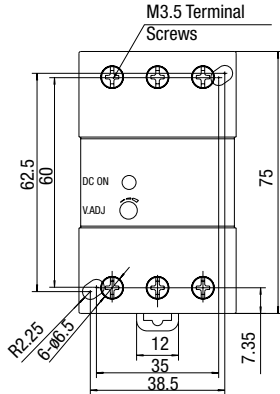

PS5R-C (30W)

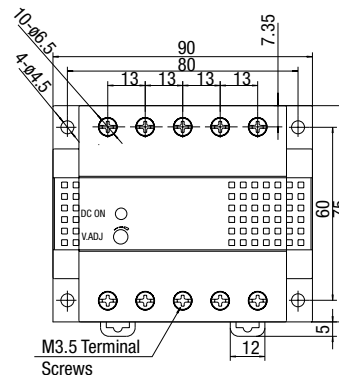

PS5R-D (50W)

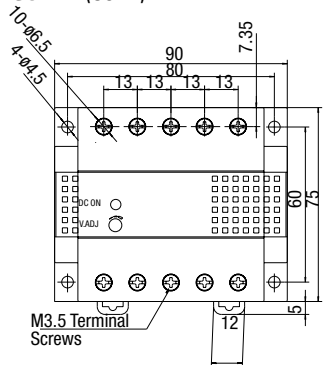

PS5R-Q (75W)

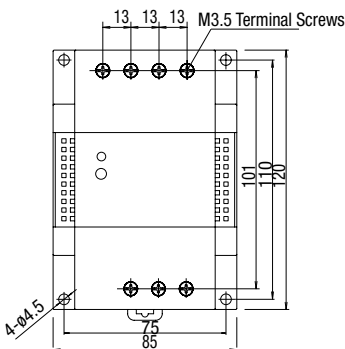

PS5R-F (120W)

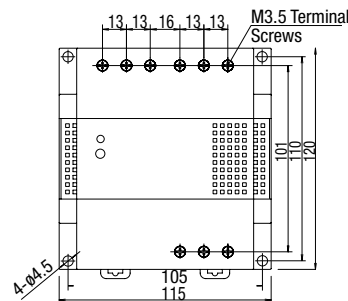

PS5R-E (100W)

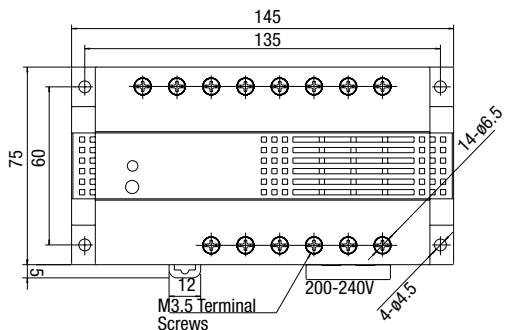

PS5R-G (240W)

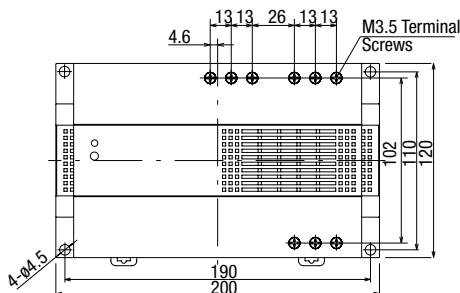

PS5R-TJ24

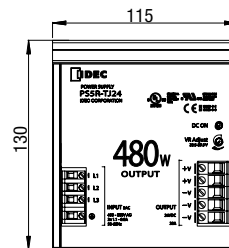

Terminal Markings

PS5R-A/B

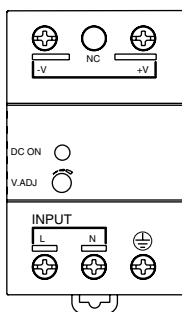

PS5R-C/D/Q/F/G

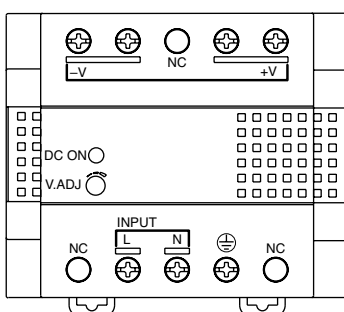

PS5R-E

