

## Sensor Applications

Application Note

January 2008  
New Information

The sensor applications on the following pages range from basic problems to complex problems that can be solved only with specific Cutler-Hammer® sensors from Eaton's electrical business.

The solution is summarized along with the Catalog Numbers of suggested models to be used. Note that many sensors are interchangeable; slight differences in the application may dictate the choice of one sensor over another. When full Catalog Numbers are listed, that specific model is suggested. Where no Suffix is given (e.g. **1451B**) or only one family is listed, the choice of a specific model within the suggested type would be determined by operating voltage, sensing range, choice of cable or connector base, etc.

### 1. Broken Tool Detection

Description	Catalog Number
E58 Perfect Prox Sensor	<b>E58-30DP or E58-18DP Sensor</b>

An E58 Harsh Duty Perfect Prox sensor is used to sense for the presence of the bit on a mill. The high sensing power and background rejection of the Perfect Prox allows reliable detection through high levels of cutting fluids, while ignoring objects just beyond the bit. The rugged harsh duty sensor survives constant exposure to lubricants, cutting fluids and flying metal chips.

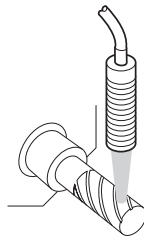

### 2. Broken Bit Detection

Description	Catalog Number
Tubular Inductive Proximity Sensor	<b>E57 Product Family or iProx</b>
Fine Spot Comet Perfect Prox	<b>13105</b>

A tubular E57 proximity sensor is used to detect the presence of a drill bit — should the drill bit be broken the sensor would signal a controller. For very small tools, a fine spot Comet Perfect Prox will reject the background while detecting a broken drill bit.

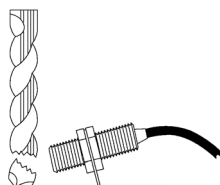

### 3. Machining Processes

Description	Catalog Number
Tubular Inductive Proximity Sensor	<b>E57 Product Family or iProx</b>

A ferrous only sensor is used in a process where aluminum is being machined. The ferrous only sensor ignores the aluminum (non-ferrous) chips from the machining process and only detects the ferrous target.

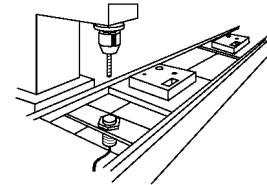

### 4. Tool Position

Description	Catalog Number
Tubular Inductive Proximity Sensor	<b>E57 Product Family or iProx</b>

A tubular E57 proximity sensor is used to detect the position of a tool chuck.

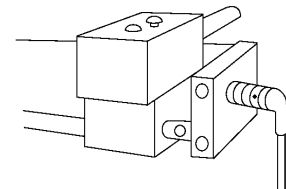

For assistance with these or other applications, contact us at **1-800-426-9184**.

## 5. Bottle Filling Detection

Description	Catalog Number
E65 Clear Object Sensor	<b>E66CBL1C or E65VBL1C</b>

A clear object sensor is used to sense the presence of bottles at a filling operation. The sensor offers high reliability in sensing clear bottles of different colors and thicknesses.

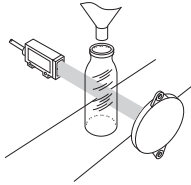

## 6. Process Control

Description	Catalog Number
Tubular Capacitive Proximity Sensor	<b>E53 Product Family</b>

A capacitive proximity sensor used to verify fill level of bottled water on a filling process line.

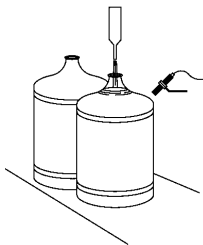

## 7. Jam Detection

Description	Catalog Number
50 Series Reflex Sensor	<b>1450B</b>
Time Delay Logic Module	<b>8251B</b>
Plug-In Relay Output Device	<b>8532B</b>
3" Diameter Retroreflector	<b>6200A-6501</b>

A reflex control with a time delay module set for "delay dark" ignores momentary beam breaks. If the beam is blocked longer than the delay period, the output energizes to sound an alarm or stop the conveyor.

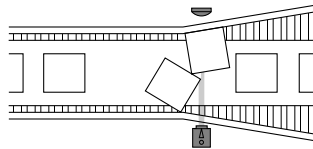

## 8. Conveyor System Control

Description	Catalog Number
Tubular Inductive Proximity Sensor	<b>E57 Product Family or iProx</b>

A tubular inductive proximity sensor is used to detect the presence of metal carriers holding parts to be machined.

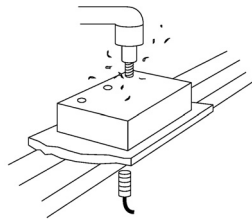

## 9. Stack Height Control

Description	Catalog Number
Comet Series Thru-Beam Source	<b>11155A</b>
Comet Series Thru-Beam Detector	<b>11255B</b>

A set of thru-beam sensors determines the height of a scissor lift. For example, when the control is set for "dark-to-light" energize, the lift rises after a layer has been removed and stops when the next layer breaks the beam again.

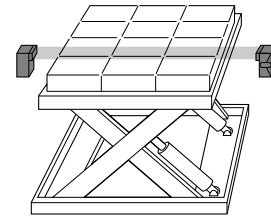

## 10. Carton Fill-Level Detection

Description	Catalog Number
Comet Visible-Beam Reflex Sensor	<b>14102A</b>
Comet 9 Inch Perfect Prox Sensor	<b>13103A</b>
3" Diameter Retroreflector	<b>6200A-6501</b>
E67 Long Range Perfect Prox (preset 3 – 8 ft.)	<b>E67-LRDP</b>

Two sensors work together to inspect the fill level in cartons on a conveyor. A reflex sensor senses the position of the carton and energizes the Perfect Prox sensor located over the contents. If the Perfect Prox sensor does not "see" the fill level, the carton does not pass inspection.

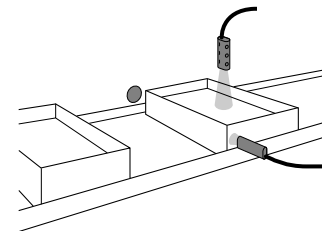

For assistance with these or other applications, contact us at **1-800-426-9184**.

**11. Box Counting**

Description	Catalog Number
Prism Polarized Reflex Sensor	<b>14151R</b>
3" Diameter Retroreflector	<b>6200A-6501</b>

A Prism right-angle reflex sensor detects boxes anywhere on a four foot wide conveyor. Interfacing the control with a programmable controller provides totals at specific time intervals. Polarized reflex optics prevent false triggering on shiny objects, while the high optical power burns through box dust and contamination.

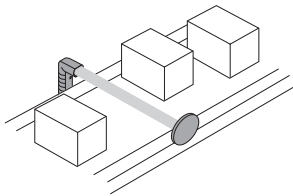

**12. Log Diverter**

Description	Catalog Number
E51 Extended Range Sensor	<b>E51CNP4</b>
Single-Shot Logic Module	<b>E51MSS</b>
E67 Long Range Perfect Prox	<b>E67-LRDP</b>

The log is detected by an extended-range diffuse reflective control with a single-shot logic module or a high power E67 Long Range Perfect Prox. The hydraulic system is energized and the log is pushed onto a lateral conveyor. The logic module (used with the E51) allows for control of output pulse timing and duration. The E67 reliably senses logs of different colors and shapes while ignoring objects in the background.

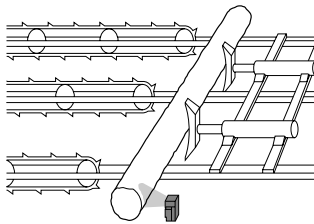

**13. Cookie Motion Detection**

Description	Catalog Number
50 Series Fiber Optic Sensor	<b>1550B</b>
One-Shot Logic Module (In Retrigger Mode)	<b>8252A</b>
Fiber Optic Thru-Beam Cable (2 Required)	<b>6221B</b>
Plug-In Relay Output Device	<b>8532B</b>

High temperature environments are accommodated by the use of fiber optics. Here conveyor motion in a 450°F cookie oven is detected. If the motion stops, the one-shot logic module detects light or dark for too long, and the output device shuts the oven down.

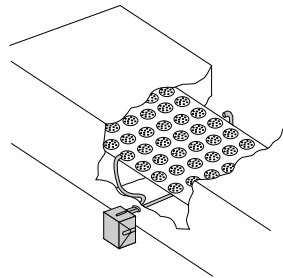

**14. Lid Detection**

Description	Catalog Number
Tubular Inductive Proximity Sensor	<b>E57 Product Family or iProx</b>

A pair of tubular proximity sensors used to, a) detect the presence of a can on a conveying line, and b) check for presence of a lid.

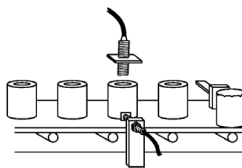

**15. Tollbooth Control**

Description	Catalog Number
20 Series Thru-Beam Source	<b>1141D-6501</b>
20 Series Thru-Beam Detector	<b>1241D-6501</b>
DPDT Relay Output Device	<b>8526A-6501</b>
E67 Long Range Perfect Prox	<b>E67-LRDP</b>

Thru-beam source/detector or the long range polarized reflex controls are used to time the toll gate. To eliminate toll cheating, the gate lowers the instant the rear of the paid car passes the control. The E67 Long Range Perfect Prox allows you to mount the sensor on one side, instead of both. Plus with Perfect Prox, the E67 will detect cars with different colors and finishes while ignoring all other background objects. The rugged control handles harsh weather, abuse and 24-hour operation.

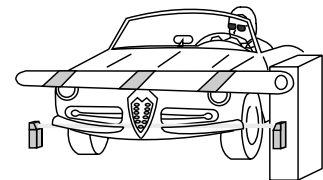

**16. Garage Door Control**

Description	Catalog Number
80 Series High Current Control Unit (2 Required)	<b>8880C-6501</b>

A safe and secure garage is achieved through the use of thru-beam controls interfaced to the door controller. The door shuts automatically after a car leaves, and if the beam is broken while the door is lowering, the motor reverses direction and raises the door again.

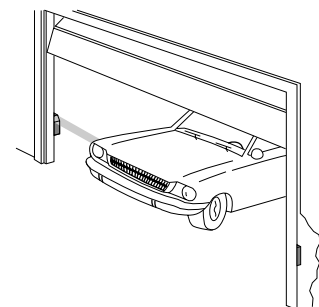

For assistance with these or other applications, contact us at **1-800-426-9184**.

**17. Cut-Off Saw Control**

Description	Catalog Number
E51 Thru-Beam Source	<b>E51ELA</b>
E51 Thru-Beam Detector	<b>E51CLC1</b>

**NOTE:** All products listed are required for each two-foot increment.

An array of thru-beam controls detect the length of the log in standard two-foot increments. The correct saw is then activated to cut the log at its longest standard length. High optical performance is a must in this dusty and dirty environment.

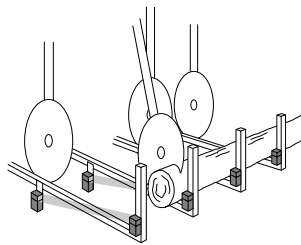

**18. Liquid Level Detection**

Description	Catalog Number
Tubular Capacitive Proximity Sensor	<b>E53 Product Family</b>

A pair of E53 capacitive proximity sensors are used to sense high and low liquid levels in a tank through a sight glass. This arrangement starts a pump to fill the tank when the lower sensor is energized and shuts the pump off when the top sensor is energized.

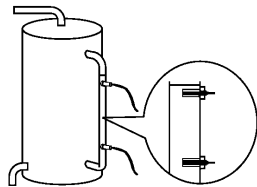

**19. Bulk Material Detection**

Description	Catalog Number
Tubular Capacitive Proximity Sensor	<b>E57 Product Family</b>

A capacitive proximity is used to control fill level of solids such as plastic pellets in a hopper or bin.

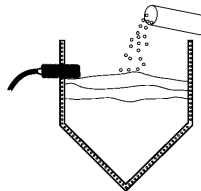

**20. Hopper Fill Level Control**

Description	Catalog Number
80 Series High Current Control Unit	<b>8880C-6501</b>
80 Series 18 Inch Diffuse Reflective Sensor	<b>1381B</b>
Time Delay Logic Module	<b>8280A</b>

The fill level on this machine hopper is controlled by a diffuse reflective control with a time delay module. The control must detect the level for a certain time interval before it energizes the shut-off mechanism. This eliminates false "full" indications caused by extraneous material momentarily passing by the control.

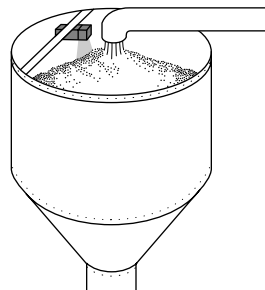

**21. Web Loop Control**

Description	Catalog Number
70 Series Analog Control Unit	<b>8172A</b>
70 Series Reflex Curtain-of-Light Sensor	<b>1471A</b>
Analog Isolation Module	<b>8272A</b>
Strip Retroreflector	<b>6210A</b>

A sensor that generates a "curtain-of-light" detects the length of a loop on a web drive system by measuring the amount of light returned from an array of retroreflectors. With this information, the analog control unit instructs a motor controller to speed up or slow down the web drive.

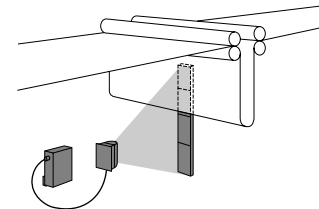

**22. Parts Presence**

Description	Catalog Number
Limit Switch Inductive Proximity Sensor	<b>E57 Product Family</b>
Comet Perfect Prox	<b>1310</b>
iProx Inductive Proximity Sensor	<b>E59F</b>

A limit switch style proximity sensor, a Comet Perfect Prox or the iProx Sensor may be used to detect the presence of a part in a pick-and-place application for inspection. The Comet will detect any target material, color or finish while rejecting the background. The iProx can be programmed to sense a specific metal target while rejecting all other metal.

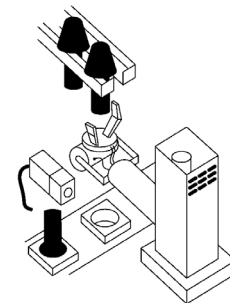

For assistance with these or other applications, contact us at **1-800-426-9184**.

**23. Small Parts Detection**

Description	Catalog Number
70 Series High Power Control Unit	<b>8171B</b>
Low Contrast Logic Module	<b>8215A</b>
70 Series Reflex Curtain-of-Light Sensor	<b>1471A</b>
Strip Retroreflector	<b>6210A</b>
Triac Output Relay or Other Selection	<b>8572A</b>

Small objects moving through a "curtain-of-light" are counted by detecting a change in reflected light. A low contrast logic module inside the control unit responds to slight but abrupt signal variations while ignoring slow changes such as dust build-up.

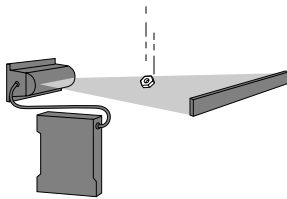

**24. Parts Detection**

Description	Catalog Number
Comet Series 4 Inch Perfect Prox Sensor	<b>13101A</b>
E67 Long Range Perfect Prox	<b>E67-LDRP</b>

A four inch Perfect Prox sensor detects parts of various heights from 0.5 to 3 inches passing through a channel, while ignoring the channel bottom. For longer range sensing up to 8 ft., use the E67 Long Range Perfect Prox. Installation is simple with no cutting or drilling of the channel required.

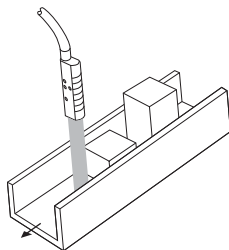

**25. Filter Paper Length Control**

Description	Catalog Number
Comet Focused Diffuse Reflective Sensor	<b>13102A</b>

A focused diffuse reflective sensor interfaces with a programmable controller to measure a specific length of corrugated automotive filter paper. The control detects the presence or absence of a corrugation. When a predetermined number of corrugations has been detected, the programmable controller directs a shear to cut the paper.

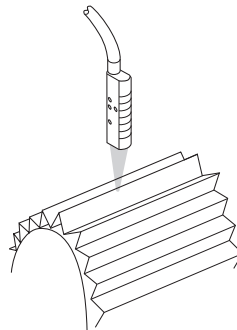

**26. Broken Thread Detection**

Description	Catalog Number
70 Series High Power Control Unit	<b>8171B</b>
Low Contrast Logic Module	<b>8215A</b>
70 Series 375 Foot Thru-Beam Source (2 Required)	<b>1173A-100</b>
70 Series 375 Foot Thru-Beam Detector (2 Required)	<b>1273A-100</b>
DPDT Relay	<b>8530A</b>
Mounting Brackets	<b>6142A</b>

A pair of remote thru-beam sensors scan over and under multiple strands of thread. If a thread breaks and passes through one of the beams, the low-contrast logic module detects the sudden change in signal strength and energizes the output. Because this logic module does not react to slow changes in signal strength, it can operate in a dusty environment with little maintenance.

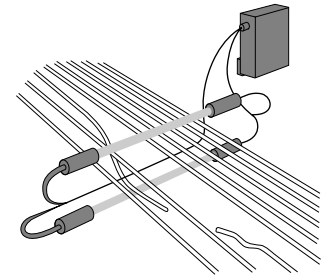

For assistance with these or other applications, contact us at **1-800-426-9184**.

**27. Hypodermic Needle Quality Control**

Description	Catalog Number
70 Series High Power Control Unit	8171B
70 Series 300 Foot Thru-Beam Source	1173A-300
70 Series 300 Foot Thru-Beam Detector	1273A-300
Triac Output Relay	8573A

A remote source and detector pair inspects for passage of light through a hypodermic needle. Their small design and waterproof stainless steel housing are appropriate for crowded machinery spaces and frequent washdowns. High signal strength allows quality inspection with hole sizes down to 0.007 inch.

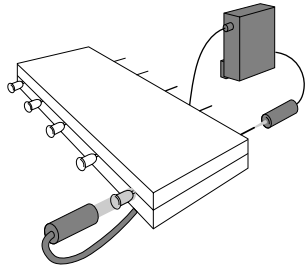

**28. Automotive Body Assembly**

Description	Catalog Number
Weld Field Immune Inductive Proximity Sensor	E57 Product Family

Automotive body assembly lines use welders which can cause standard inductive proximity sensors to perform erratically. Cutler-Hammer Weld-Field Immune Sensors from Eaton's electrical business are designed to provide reliable operation in these environments.

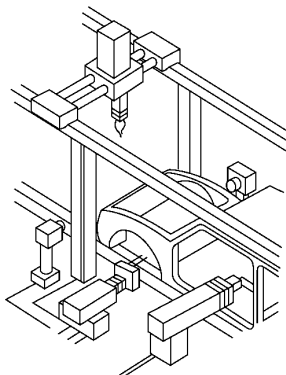

**29. Multi-Hole Casting Inspection**

Description	Catalog Number
70 Series Modular Control Unit (4 Required)	8771A
70 Series 35 Foot Thru-Beam Source (4 Required)	1173A-300
70 Series 35 Foot Thru-Beam Detector (4 Required)	1273A-300
Panel Mount Socket for Control Unit (4 Required)	8905A

Remote sensors inspect for the presence of holes in a metal casting. Because each hole has its own inspection system, accurate defect information is recorded. Rugged sensor housing and extremely high signal strength handle dirt and grease with minimum maintenance. Using the modular control unit allows for dense packaging in small enclosures.

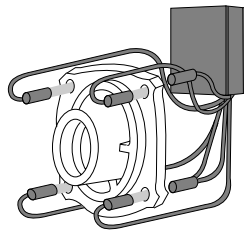

**30. Web Flaw Detection**

Description	Catalog Number
70 Series High Power Control Unit	8171B
Low Contrast Logic Module	8215A
DPDT Relay	8530A
70 Series Reflex Curtain-of-Light Sensor	1471A
Strip Retroreflector	6210A

A web passes over an array of retroreflectors. When light is returned to the sensor head, the output is energized and the web shuts down. Because of the superior response time of the control unit, high web speeds can be maintained.

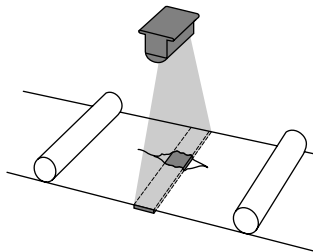

**31. Over/Underspeed Control**

Description	Catalog Number
50 Series Reflex Sensor	1450B
Motion Detection Logic Module	8253A
Solid-State Switch Output Device	8562B
3 inch Diameter Retroreflector	6200A-6501

A reflex sensor with a motion detection module counts the revolutions of the wheel. Speed is controlled by a programmable controller. Provides timing ranges from 2.4 to 12,000 counts per minute.

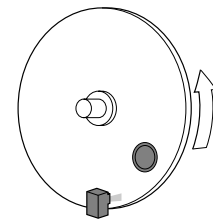

**32. Motion Position Detection**

Description	Catalog Number
Tubular Inductive Proximity Sensor	E57 Product Family or iProx

A tubular E57 proximity sensor is used to detect the presence of set screws on a shaft hub providing a control device with signals for speed regulation or detection of rotation.

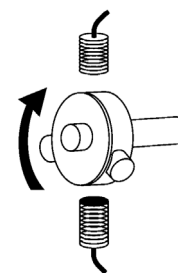

For assistance with these or other applications, contact us at 1-800-426-9184.

**33. Motion Control**

Description	Catalog Number
Tubular Inductive Proximity Sensor	<b>E57 Product Family or iProx</b>

A pair of tubular proximity sensors is used to determine full open and fully closed valve position.

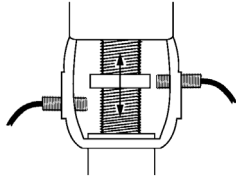

**34. Clear Plastic Web Break Detection**

Description	Catalog Number
80 Series High Current Control Unit	<b>8880C-6501</b>
80 Series 7 Inch Diffuse Reflective Sensor	<b>1380B</b>

The clear web is detected by an extremely sensitive diffuse reflective sensor. Its short detection range makes it immune to reflective objects in the background. The extremely high excess gain helps it ignore reflection caused by fluttering of the web.

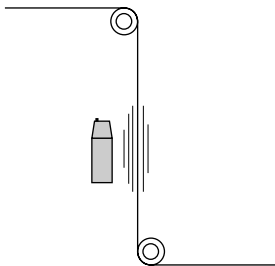

**35. Web Splice Detection**

Description	Catalog Number
70 Series Differential Control Unit	<b>9072A</b>
One-Shot Logic Module	<b>8213A</b>
DPDT Relay	<b>8526A</b>
70 Series 30 Foot Thru-Beam Source (2 Required)	<b>1173A-300</b>
70 Series 30 Foot Thru-Beam Detector (2 Required)	<b>1273A-300</b>

When the two thru-beam detectors see the same signal strength, the output is zero. When the opacity of the web changes, as in a splice, the signal strengths are thrown out of balance and the output is energized. This system can be used on webs of different colors and opacities with no system reconfiguration.

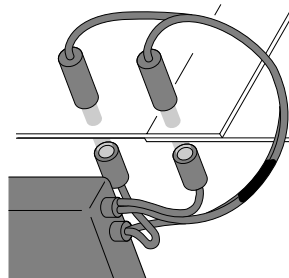

**36. Paper Presence Detection**

Description	Catalog Number
Comet Series 2 Inch Right Angle Perfect Prox Sensor	<b>13104R</b>

Right angle viewing and compact size allow the sensor to be mounted in the tight confines of paper handling systems. High gain and sharp optical cut-off ensure that background machinery will be ignored while paper will be detected regardless of color and texture.

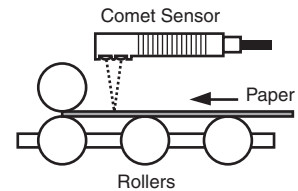

**37. Web Guiding**

Description	Catalog Number
70 Series Slot Sensor	<b>1372A-6501</b>
70 Series Analog Control Unit	<b>8172A</b>

The 1372A-6501 slot sensor head is mounted so that the edge of the web extends into the slot and blocks half of the source beam. As the web moves into or out of position, a proportional signal is provided by the analog control unit to alert your control system.

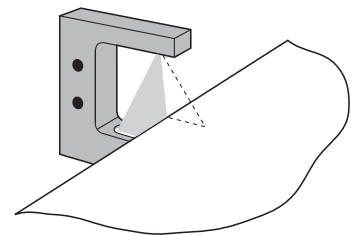

For assistance with these or other applications, contact us at **1-800-426-9184**.

**38. Damage Warning**

Description	Catalog Number
Comet Series 100 Foot Thru-Beam Source	<b>11102A</b>
Comet Series 100 Foot Thru-Beam Detector	<b>12102A</b>

Source and detector are mounted at opposite ends of a long warehouse storage shelf with the beam situated a safe distance below overhead obstacles (lighting, conduit, gas lines, ducts, pipes, etc.). If a forklift operator interrupts the beam while moving a load, a siren or flashing light will warn him to stop before any damage occurs.

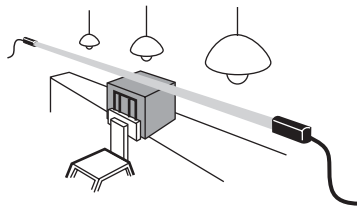

**39. Zero Pressure Accumulation Conveyor**

Description	Catalog Number
E68 Integral Sensor Valve	<b>E68-SVS</b>
200 Series Zero Pressure Accumulation	<b>14286/14266</b>

E68 Series or 200 Series sensors detect and control the movement of boxes on the conveyor, to maximize throughput and eliminate line pressure between boxes. The sensor contains all required logic with no need for a PLC.

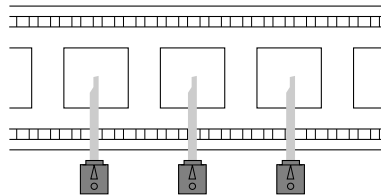

For assistance with these or other applications, contact us at **1-800-426-9184**.

Eaton Corporation  
 Electrical Group  
 1000 Cherrington Parkway  
 Moon Township, PA 15108  
 United States  
 877-ETN CARE (877-386-2273)  
 Eaton.com