



ALL RIGHTS RESERVED. NO PORTION OF THIS PUBLICATION, WHETHER IN WHOLE OR IN PART CAN BE REPRODUCED WITHOUT THE EXPRESS WRITTEN CONSENT OF SPC TECHNOLOGY.

SPC-F005.DWG

REVISIONS

DOC. NO. SPC-F005 * Effective: 7/8/02 * DCP No: 1398

DCP #	REV	DESCRIPTION	DRAWN	DATE	CHECKD	DATE	APPRVD	DATE
392	A	RELEASED	J.W.M.	7/14/98	J.C.	7/29/98	D.J.C.	7/30/98
1865	B	RoHS ADDED	DCM	10/30/05	JWM	10/31/05	JWM	10/31/05

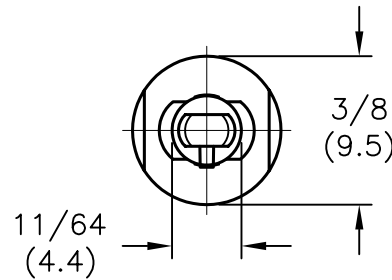

TO SNAP-LOCK IN A $.125 \pm .002$ (3.18 \pm 0.05) DIA. HOLE, IN A $.062$ (1.57) THICK BOARD/PANEL

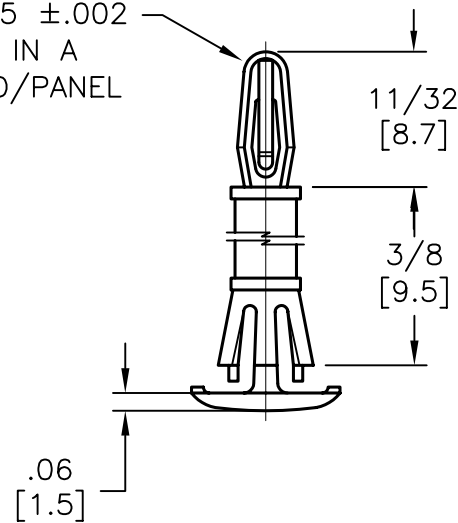

NOTES:

- MAT'L: NYLON 66
- COLOR: NATURAL

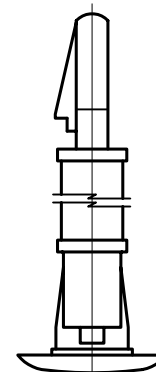

TO SNAP-LOCK IN A $.187 \pm .003$ (4.75 \pm 0.08) DIA. HOLE, IN A $.059$ (1.50) TO $.063$ (1.60) THICK PANEL/CHASSIS

DISCLAIMER:
ALL STATEMENTS AND TECHNICAL INFORMATION CONTAINED HEREIN ARE BASED UPON INFORMATION AND/OR TESTS WE BELIEVE TO BE ACCURATE AND RELIABLE. SINCE CONDITIONS OF USE ARE BEYOND OUR CONTROL, THE USER SHALL DETERMINE THE SUITABILITY OF THE PRODUCT FOR THE INTENDED USE AND ASSUME ALL RISK AND LIABILITY WHATSOEVER IN CONNECTION THEREWITH.

TOLERANCES:
UNLESS OTHERWISE SPECIFIED, DIMENSIONS ARE FOR REFERENCE PURPOSES ONLY.

DRAWN BY:	DATE:
Jeff McVicker	7/14/98
CHECKED BY:	DATE:
John Cole	7/29/98
APPROVED BY:	DATE:
Daniel Carey	7/30/98

DRAWING TITLE: Reverse Locking, Round Hole Spacer			
SIZE	DWG. NO.	ELECTRONIC FILE	REV
A	2631	92N4846.dwg	B
SCALE: NTS		U.O.M.: INCHES [mm]	SHEET: 1 OF 1