

ALL RIGHTS RESERVED. NO PORTION OF THIS PUBLICATION, WHETHER IN WHOLE OR IN PART CAN BE REPRODUCED WITHOUT THE EXPRESS WRITTEN CONSENT OF SPC TECHNOLOGY.

SPC-F005.DWG

REVISIONS

DCP #	REV	DESCRIPTION	DRAWN	DATE	CHECKD	DATE	APPRVD	DATE
			VEE	19-10-10	JAG	19-10-10	XXX	02-11-10

DOC. NO. SPC-F005 * Effective: 7/8/02 * DCP No: 1398

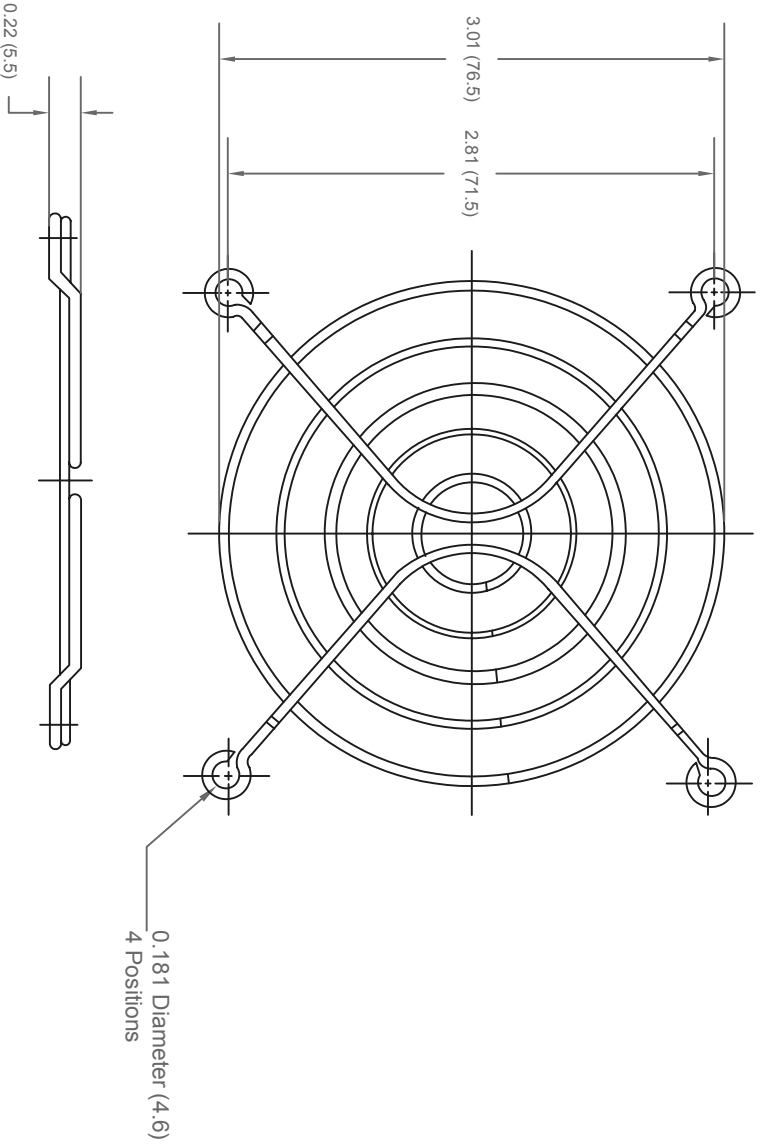
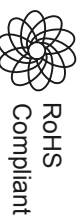

0.181 Diameter (4.6)
4 Positions

Notes:

- Material : C1008 Steel
- Plating : Black electrodeposit plating
- Ring Diameter : 1.8mm
- Rib Diameter : 1.8mm

Part Number Table

Description	Part Number
Wire Fan Guard	MC32794

Dimensions : Inches (mm)

TOLERANCES:

UNLESS OTHERWISE SPECIFIED, DIMENSIONS ARE FOR REFERENCE PURPOSES ONLY.

DISCLAIMER:

ALL STATEMENTS AND TECHNICAL INFORMATION CONTAINED HEREIN ARE BASED UPON INFORMATION AND/OR TESTS WE BELIEVE TO BE ACCURATE AND RELIABLE. SINCE CONDITIONS OF USE ARE BEYOND OUR CONTROL, THE USER SHALL DETERMINE THE SUITABILITY OF THE PRODUCT FOR THE INTENDED USE AND ASSUME ALL RISK AND LIABILITY WHATSOEVER IN CONNECTION THEREWITH.

DRAWN BY:

VEE

DATE:

19-10-10

CHECKED BY:

JAG

DATE:

19-10-10

APPROVED BY:

XXX

DATE:

02-11-10

DRAWING TITLE:

Wire Fan Guard

SIZE DWG. NO.

A MC32794

ELECTRONIC FILE

56P2990

SCALE: NTS

U.O.M.: Millimeters

SHEET:

1 OF 1