

Product Number: 3609-3-07-21-00-00-08-0

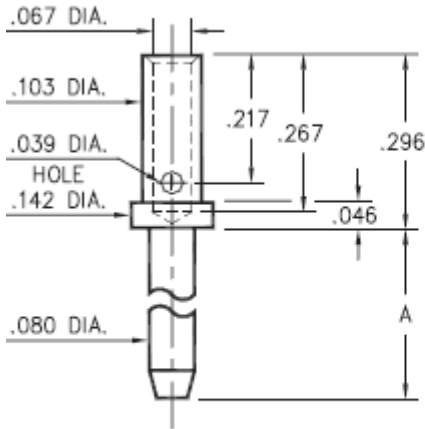

Basic Part Number	Pin Length A
3609-1	.200
3609-2	.375
3609-3	.500

Description:

3609 - Wire Crimp Pin

Packaging:

Packaged in Bulk

3609-X-07-XX-00-00-08-0

#16A Crimp barrel

Mill-Max Part Number	Shell Plating	Contact Plating	RoHS Compliant
3609-3-07-21-00-00-08-0	20 μ" Gold over Nickel	00	

SHELL MATERIAL:

BRASS ALLOY (UNS C36000) per ASTM B 16

Properties of BRASS ALLOY:

- Chemical composition: Cu 61.5%, Zn 35.4%, Pb 3.1%†
- Hardness as machined: 80-90 Rockwell B
- Density: .307 lbs/in³
- Electrical conductivity: 26% IACS*
- Melting point: 900°C/885°C (liquidus/solidus)

†(3 to 4% lead is used to permit "free machining" and is permitted by EC Directive 2002/95Annex 6; so all pin materials are RoHS compliant)

*International Annealed Copper Standard, i.e. as a % of pure copper.